

GSM/GPRS/GPS Vehicle Tracker

Model A/B/C User Manual

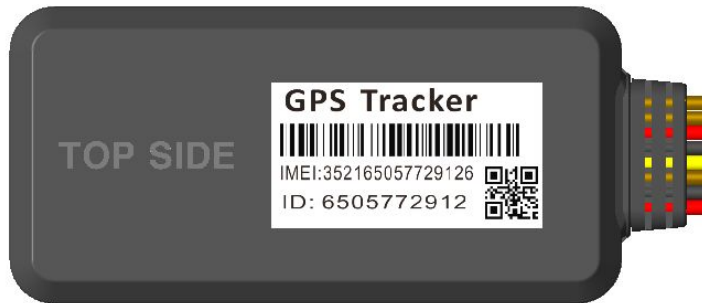

Preface

Thank you for purchasing the tracker. This manual shows how to operate the device smoothly and correctly. Make sure to read this manual carefully before using this product. Please note that specification and information are subject to changes without prior notice in this manual. Any change will be integrated in the latest release. The manufacturer assumes no responsibility for any errors or omissions in this document.

Contents

1.	Function Introduction.....	3
2.	Applications.....	3
3.	Hardware Description.....	3
4.	Accessories.....	错误! 未定义书签。
5.	Specifications.....	5
6.	Operating Instructions.....	6
6.1	Terminal Installation.....	6
6.2	SIM CARD Installations.....	7
6.3	Turn on the Tracker Device.....	7
6.4	GSM/GPS LED Indicator.....	8
6.5	Change Password.....	8
6.6	Authorization.....	9
6.7	Single Locating.....	9
6.8	Exact street address.....	9
6.9	Location based service (LBS) / Cell-ID Locating.....	9
6.10	Change Work Mode.....	10
6.11	Monitor.....	10.
6.12	Location Data Logging and Loading.....	10
6.13	Armed by ACC	11
6.14	Cut off the Oil and Power System.....	11
6.15	Armed Setting.....	11
6.16	Disarmed Setting.....	11
6.17	Alarms.....	12
6.17.1	Power off alarm.....	12
6.17.2	SOS Alarm.....	12
6.17.3	Movement alarm.....	12
6.17.4	Over speed alarm.....	12
6.17.5	ACC Alarm.....	12
6.18	Check the Vehicle State.....	13
6.19	Check IMEI.....	14
6.20	Terminal (local) Time Setting.....	14
6.21	Reset Hardware.....	14
6.22	GPRS Setting.....	14
6.23	Less GPRS traffic.....	15
6.24	Instructions for web platform and mobile APP.....	15
7.	Cautions.....	19
8.	Faults & the Solutions.....	20

1. Function Introduction

1.1. This tracker is a new product based on the GSM / GPRS network and GPS satellite positioning system, which set multiple functions of security, positioning, monitoring surveillance, emergency alarms and tracking in its entirety. It can track and monitor remote target by SMS or internet.

1.2. Features

1.2.1 Support both GPS & LBS (Location based service).

1.2.2 Support SMS/GPRS/Internet Network data transmission

1.2.1 Support GPRS on-line and GPRS re-connected automatically if GPRS drops

1.2.3 Support SMS / GPRS dual-mode switching

1.2.4 Support configuration by remote terminal.

1.2.5 Support for point-to-point, point to group, group-to-group monitoring.

1.2.6 Set multiple functions of security, positioning, monitoring surveillance, emergency alarms and tracking in its entirety.



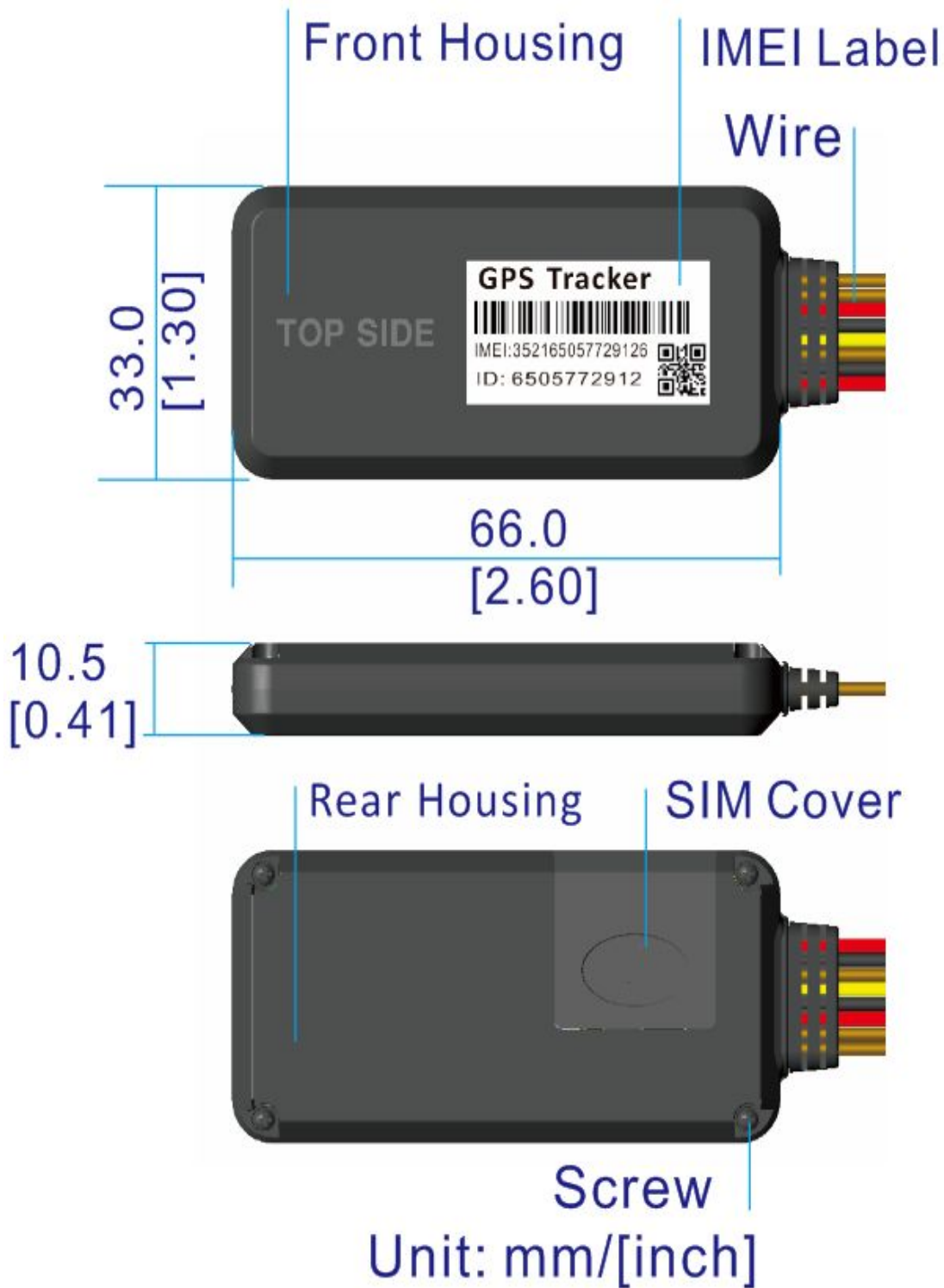

2. Applications

Used widely for vehicle and other moving objects tracking.

3. Hardware Description

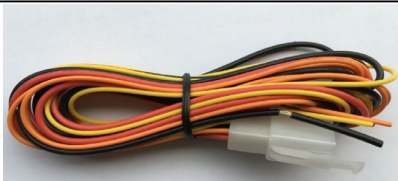

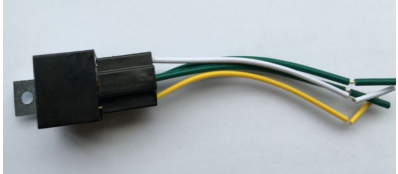
4. Accessories

No.	Photoes	NAME	Note
1		Harness (Default)	4 PIN
2		Microphone	1.5 meters
3		Relay	12VDC/40A to 24VDC/40A according to vehicles
4		SOS Key	SOS Key/Cable for Help Call

5. Specifications

Content	specifications
DIM	68.0X33.0X10.5mm
Weight	35g
Network	GSM/GPRS
Band	850/900/1800/1900Mhz
GPS Sensitivity	-159dBm
GPS Accuracy	5m
GPS Start time	Cold status 45s Warm status 35s Hot status 1s
Voltage	9 V~40V
Backup battery	Chargeable 3.7V 70mAh Polymer Li-Battery
Storage Temp.	-40°C to +85°C
Operation Temp.	-20°C to +65°C
Humidity	5%--95% non-condensing

6. Operating Instructions

6.1 Terminal Installation

6.1.1 Please ask the qualified engineers to install it.

6.1.2 Do not install it in an environment which is over GSM performance index, and please pay attention to fix the antennas in an appropriate position with good signals.

6.1.3 Pay attention to make installation location preventing water and dust.

6.1.4 Find the 4 PIN harness and insert it into the corresponding holes of the products, and connect the wires with the original car circuit showing below:

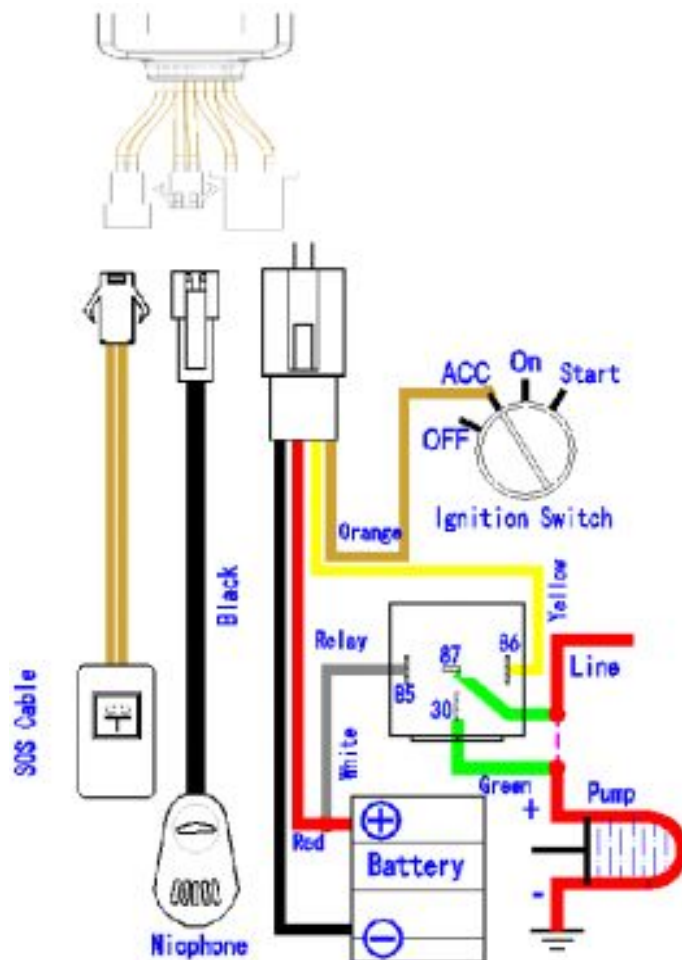

Wiring diagram

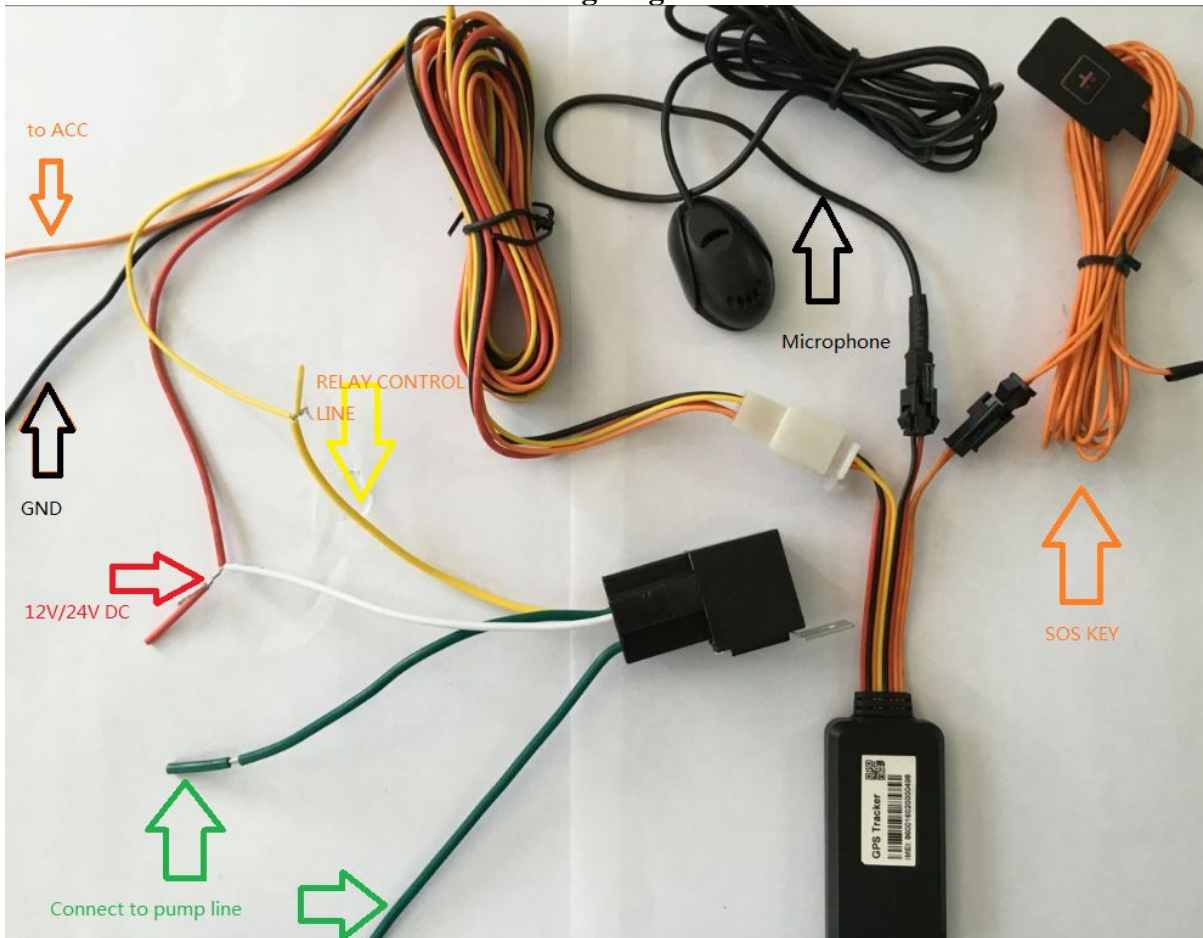

Note: The orange wire can be connected to the original car horn

- 6.1.5 Please put SOS button at the place driver can touch.
- 6.1.6 Insert the external monitor Microphone into the monitor jack.
- 6.1.7 Please let the TOP SIDE of Tracker upwards the sky, make sure it receives GPS signals well.

6.2 Micro SIM CARD Installations

- 6.2.1 Take out the SIM card Slot and put Micro SIM card in it. And then put the SIM card slot back to its original position after confirm the Micro SIM card in the right place.
- 6.2.2 Please make sure the Micro SIM card is for GSM network and able to execute the function of incoming calls display, no calls can be diverted and the PIN code is locked. The SMS format must be TXT format, and can't recognize the PDU format.

6.3 Turn on the Tracker Device

Connect the positive and negative wire, red and black ones, with 12V or 24V car power system, It will be powered on after 20 seconds.

6.4 GSM/GPS LED Indicator

LED Indicator Type	Behavior	Meaning
Red LED	On(Not Flash)	SIM not Ready
	Flash quickly	GSM search Network(1 time per second) GPRS uploading data(3 time per second)
	Flash slowly	GPRS Normal or in Sleep mode (1 time per 5 seconds)
	Off(Optional)	After bootup 5 minutes
Blue LED	Flash Slowly	Fix to satellites (1 time per 5 seconds)
	Flash quickly	Lost fix to satellites (1 time per second)
	Off(Optional)	After bootup 5 minutes



6.5 Change Password

6.5.1 Send SMS“Password,CURRENT PASSWORD,NEW PASSWORD”to the unit to change the password.

For Example:

Send SMS “Password,123456,888888” to the tracker.

If succeeded, “Password setting ok!”will reply to your cell phone from the tracker.

Note: the default Password is **123456**, seperator is **comma**.

6.5.2 Be sure to keep the new password in mind, you have to upload the software to restore the original setting in case of losing the new password.

6.5.3 Attention: Make sure the new password is in 6 digits Arabic numbers, or else the tracker cannot recognize the password.

6.5.4 When reading this user manual, you will notice that we have used **English format** “,”

between some words;

6.6 Authorization

- 6.6.1 **You should setup the authorized phone number before using SOS, Movement, Over Speed alarm, etc. Up to 3 numbers can be authorized.**
- 6.6.2 Authorization: Send SMS "Admin,password,index,cell phone number" to set up an authorized number, if the number is successfully authorized, the unit will reply "Admin phone number setting ok!" by SMS.
- 6.6.3 Delete authorization: Send SMS "Admin,password,index,d" to delete the authorized number.
- 6.6.4 If you want to track the target when it enters into another country, you must add the country code before the cell phone number. You should authorize your number in international format as follows: "admin,123456,1,008613421342519" to tracker to set 13421342519 as an authorized number.

Note: the value of index is from 1~3

6.7 Single Locating

- 6.7.1 Send SMS "Url,password" to the tracker to get the location report.

If there aren't any authorized number set-up, it will reply all SMS from all the mobile number; if there are authorized numbers set-up, then it only reply the authorized numbers

For example:

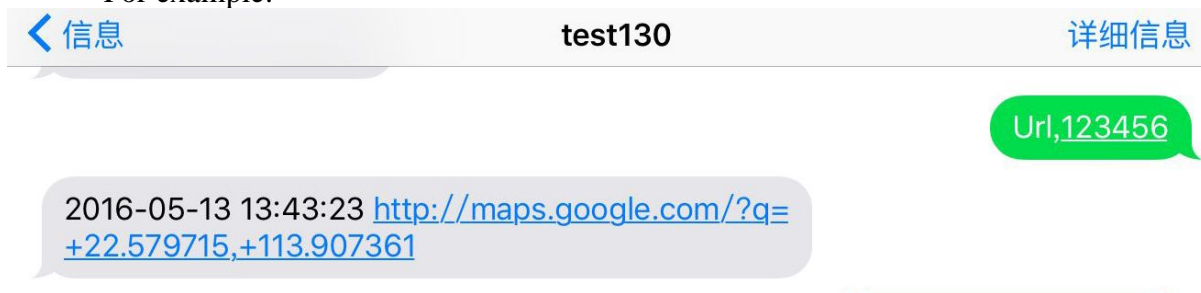

6.8 Exact street address

- 6.8.1 You must set up the APN of your local GSM network for the SIM card in tracker first before using this function.(APN set Up refer 6.22 **GPRS Setting**)
- 6.8.2 Send SMS "Loc,password" to get the real street/address name, After configure the APN.
Reply example: No.118, Chuangyue 2nd Rd, Bao An district, Huizhou, Guangdong, china.

6.9 Location based service (LBS) / Cell-ID Locating

If the tracker cannot establish a solid GPS Fix, it will calculate its location using Cell-ID GSM locating, Location reports will include the GPS coordinates of the last known positions as well as a LAC code, Entering the LAC code to the web tracking platform www.gpsgreat.com.net will enable you to see the tracker's current location. You can also send command "Loc,password" to the tracker to request exact address, track will automatically switch to tracking by LBS in GPRS mode. Accuracy of LBS depends on the distance to the nearest GSM Network Cell Tower or Base Station.

Note: This feature can be used normally in most areas according to the signal of GSM network. It may not be available in some areas.

6.10 Change Work Mode

Send command "Mode,password,value" to tracker to set up the work mode. If successful it will reply "Work mode setting ok!".

Note: value: 0~5

0 – Sleep Mode (GPS/GPRS OFF, GSM ON), No Time parameter.

Example: mode,123456,0

1 – Normal Mode (GPS/GSM/GPRS ON). No Time parameter.

Example: mode,123456,1

2 – LBS Mode (GPS/GSM/GPRS ON). No Time parameter.

Example: mode,123456,2

3 – Air Mode (GPS/GSM/GPRS OFF, it will change to Normal Mode after some minutes).

Example: mode,123456,3,30 (enter air mode 30 minutes)

4 – Deep Sleep Mode (GPS/GSM/GPRS OFF, it will wake up once very day).

Example: mode,123456,4,2300(wake up and upload location to server when 23:00 very day)

5-- Location Logging Mode(GPRS off, GPS On). The location info will be save to the internal memory of tracker. They will be uploaded when back to normal mode.

Example: mode,123456,5

6 – Tracking Mode (GSM/GPRS ON, GPS no Sleep). No Time parameter.

Example: mode,123456,6

Note: the default Mode is 1(Normal Mode).

6.11 Monitor

6.11.1 Send SMS "Monitor,password, monitor phone number" to the unit, and it will call back the phone number, if you accept the call it will enter the monitor mode.

Example: Monitor,123456,13421342519

6.11.2 It will be switched to "track" mode after ending the call.

6.11.3 It will accept the call if the monitor phone number is the incoming call.

6.12 Location Data Logging and Loading

- 6.12.1 Auto logging: When the tracker device lost GSM signals or fall offline from GPRS, tracker will log the tracking position and alerts automatically in the memory of device, when GSM signals get back, the logged tracking data should be loaded to the web platform automatically.
- 6.12.2 Current location data logging: Send SMS: "Mode,password,5" to tracker device, it will reply: "Work mode setting ok!" and the tracker will stop upload location info to gprs server, and logging them into the memory of tracker.
- 6.12.3 Loading save data to the gprs server: Send SMS: "Mode,password,1" to tracker device, it will reply: "Work mode setting ok!" and loading the tracking data to the web server platform.

6.13 Armed by ACC

- 6.13.1 Alarm will be disarmed when ACC on, if in auto Armed mode.(which Setting by SMS: armed,password,3)
- 6.13.1 Alarm will be armed when ACC off, if in auto Armed mode. (which Setting by SMS: armed,password,3)

6.14 Cut off the Oil and Power System

- 6.14.1 Send SMS command "Relay,password,1" to tracker, tracker will execute it and reply "Stop engine will be executed!". And it will remain immobile state until next command to resume.
It will be executed after speed less than 20KM/H.
Example: Relay,123456,1
- 6.14.1 Resume the Oil and Power System
Send SMS command "Relay,password,0" to tracker, it will reply "Resume engine succeed!", it means the oil supply is resumed.

Note: This function can be executed by the administrator only. So we must use SMS Admin command to set the Authorization before using this command.

6.15 Armed Setting

- 6.15.1 Set up arm by SMS "armed,password,value" to the tracker device in the vehicle.

It will reply "Armed !".

For Example: Armed,123456,1

Note: value = 0 Disarmed,

1 armed by manual,

2 armed auto setting by ACC ON/OFF.(default)

6.16 Disarmed

6.16.1 Disarmed by SMS

Send SMS command "armed,password,0" to the tracker device in the vehicle,

It will reply "Disarmed !" .

For Example: Armed,123456,0

6.17 12V/24V DC Power Turn Off Alarms

6.17.2 Setting: Send SMS "AlarmMode,password,5, index"

Index=1: SMS alarm (default)

Index=2: Call alarm

Index=3: SMS and Call alarm

When 12V/24V DC Power Turn Off, the tracker will send SMS "Ext Power Failure Alarm!+lat./long." to all the authorized numbers at interval of 5 seconds. Or Call the authorized numbers at interval of 5 seconds.

6.17.2.1 Cancel: Send SMS "AlarmMode,password,5,0" to deactivate the Power Off alarm.

6.17.2.2 Setting: Send SMS "AlarmMode,password,5,1",

1: SMS alarm (default) 2:Call alarm 3: SMS and Call alarm. 0:Disable

Note: to protect the power of vehicle, the device enter sleep mode automatically when the power voltage below than 12V/24V. Low power alarm voltage can be set by SMS: vpower,password,vol (For example: vpower,123456,12)

6.17.3 SOS Alarm

6.17.3.1 Setting: Send SMS "AlarmMode,password,1, index"

Index=1: SMS alarm Index=2: Call alarm Index=3: SMS and Call alarm(default)

After setting Long Press the SOS button for 3 seconds,the tracker device will send SMS "SOS Alarm!+lat./long." to all the authorized numbers at interval of 5 seconds.

6.17.2.2 Cancel: Send SMS "AlarmMode,password,1,0" to deactivate the SOS alarm

6.17.2.3 Setting: Send SMS "AlarmMode,password,1,1",

1: SMS alarm(default) 2:Call alarm 3: SMS and Call alarm. 0:Disable

6.17.4 Movement Alarm

6.17.3.1 Setting: Send SMS "AlarmMode,password,4,index"

Index=1: SMS alarm Index=2: Call alarm Index=3: SMS and Call alarm

After setting Movement be detected by tracker, it will send SMS "Movement Alarm!+lat./long." to all the authorized numbers at interval of 5 seconds. Or Call the authorized numbers at interval of 5 seconds.

6.17.3.2 Cancel: Send SMS “AlarmMode,password,4,0” to deactivate the movement alarm.

6.17.3.3 Setting: Send SMS “AlarmMode,password,4,1”,

1: SMS alarm 2:Call alarm 3: SMS and Call alarm 0:Disable(default)

6.17.5 Over speed Alarm

6.17.5.1 Setting alarm Mode : Send SMS “AlarmMode,password,3,index”

Index=1: SMS alarm Index=2: Call alarm Index=3: SMS and Call alarm

After set up the alarm mode, setting the over speed alarm : Send SMS

“speed,password,080” to the unit (suppose the speed is 80km/h), and it will reply

“Overspeed alarm setting ok!”. When the target moves exceeding 80km/h, the unit

will send SMS “SpeedOver Alarm! + latitude & longitude” to all the authorized

numbers at interval of 5 seconds. Or Call the authorized numbers at interval of 5 seconds..

6.17.5.2 Cancel: Send SMS “AlarmMode,password,3,0” to deactivate the overspeed alarm.

6.17.5.3 Setting: Send SMS “AlarmMode,password,3,1”,

1: SMS alarm 2:Call alarm 3:SMS and Call alarm 0:Disable(default)

Remark: The recommended speed should be not less than 30km/h. For below that rate, it will be effected the accuracy by GPS signals drift etc.

6.17.6 ACC Alarm when in manual armed mode

6.17.6.1 Setting: Send SMS “AlarmMode,password,6,index”

Index=1: SMS alarm Index=2: Call alarm Index=3: SMS and Call alarm

After setting ,when the ACC on ,The unit will send SMS “ACC On Alarm!+lat/long”

to all the authorized numbers at interval of 5 seconds. Or Call the authorized numbers

at interval of 5 seconds..

6.17.6.2 Cancel: Send SMS “AlarmMode,password,6,0” to deactivate the movement alarm.

6.17.6.3 Setting: Send SMS “AlarmMode,password,6,1”,

1: SMS alarm 2:Call alarm 3:SMS and Call alarm 0:Disable(default)

Note: it is valid in the manual armed mode only. (setting by SMS: armed,123456,1)

6.17.7 Vibrator Alarm

6.17.3.1 Setting: Send SMS “AlarmMode,password,2,index”

Index=1: SMS alarm(Default) Index=2: Call alarm Index=3: SMS and Call alarm

After setting, if Vibrator be detected by tracker, it will send SMS “Vibrator Alarm!+lat./long.”

to all the authorized numbers.. Or Call the authorized numbers.

6.17.3.2 Cancel: Send SMS “AlarmMode,password,2,0” to deactivate the movement alarm.

For example: Alarmmode,123456,2,1

6.18 Check the Vehicle State

6.18.1 Check setting, Send SMS command "Param,password" to the tracker in the vehicle, It will reply SMS as following:

ID: ID NUMBER
Imei:IMEI
Apn:APN
IP:Domain or IP:Port Number
Interval:Sampling time (ACC On)Sampling time(ACC Off)
Mode: 1
GPRS Enable:1
TimeZone: 8.0

6.18.2 Check Vehicle State, Send SMS command "Status,password", It will reply SMS as following:

ID: ID No.
ACC: 1 or 0
Mileage:850
GSM:50
GPS Sat:13

6.19 Check IMEI

6.19.1 Send SMS command "imei?,password" to the device.

Example: Send SMS command

"imei?,123456" to the tracker device, it will reply an IMEI number in 15 digits to your cell phone.

6.20 Terminal (local) Timezone Setting

6.20.1 Send SMS command "TimeZone,password,timezone" to the device, If succeed, it will reply "Timezone setting ok!"

For example: Send SMS "TimeZone,123456,8.0", 8.0 is Chinese time zone,

If your country time zone is minus, send SMS "timezone,123456,-6.0".

6.21 Reset Hardware

6.21.1 Send SMS "reset,password" to tracker device to reset the GSM module and GPS module of the tracker device, it will reply "Reset ok!". It will be reset after 5 seconds.

6.22 GPRS Setting

User must send SMS via cell phone to set up APN, IP and port before starting tracking by GPRS.

6.22.1 Configure APN

APN standards for Access Point Name and differs from country to country. For more information about your local APN, please inquire with your local GPRS network operator.

6.22.1.1 Send a SMS command to tracker “APN,password ,your local APN” via a cell phone and if succeeded, the tracker will reply “APN setting ok!”.

For example: Send SMS command “APN,123456,CMNET”. If succeeded, the tracker will reply “APN setting ok!”.

Notes: 123456 refer to password of tracker and CMNET is the APN of one of china GPRS Network Operator (China mobile).

6.22.2 GPRS User Name and password Setup

In most countries, the user name and password involving GPRS login are not compulsorily necessary, therefore, the entry can be skipped. As for those countries require user name and password, please configure as following:

6.22.2.1 Send SMS “APN,password,your local apn,user,password” If succeeded, the tracker will reply “APN setting ok!”

For Example, send SMS “APN,123456,internet.beeline.ru,beeline,beeline” to the tracker, and if succeeded, tracker will reply “APN setting ok!”

Note: 123456 is password for the tracker..

6.22.3 IP and Port Setup

Send SMS as below via a cell phone: “IP,password,IP Address,Port Number”.
If succeeded, tracker will reply “IP and port setting ok!”.

For example: Send SMS command “IP,123456,120.24.83.93,8011” to the tracker, If succeeded, it will reply “IP and port setting ok!”. (123456 is default password, 120.24.83.93 is IP, 8011 is port).

6.23 Less GPRS traffic

6.23.1 Tracker will change to less GPRS traffic mode after parking 5 minutes (ACC is OFF), Upload interval will as ACC Off upload interval.

For Examples: interval,123456,30,1800 upload interval as 30s when ACC on,upload interval will be changed as 1800s when ACC Off.

6.24 Instructions for web platform and mobile APP

Users need to regsiter an account on www.gpsgreat.com before use web or APP platform, account name and password is the same on web/APP platform

6.24.1 Configure your tracker to web platform to track it online

step 1: set APN, refer to 6.35.1

Step 2: set GPRS user name and password, refer to 6.35.2

Step 3: set IP and port, please use the corresponding IP and port of the server you choose, refer to 6.35.3

6.24.2 Login by Account

NOTE: Different ID from IMEI No. with Different GPRS Protocol.

ID = IMEI No. for Goomi Protocol

Example: ID=**706820120206006** IMEI=**706820120206006**

ID = 10 digits of IMEI No. for TianQin Protocol(**default**)

Example: ID=**2012020600** IMEI=**706820120206006**

ID = 11 digits of of IMEI No. for HongYuan Protocol

Example: ID=**20120206006** IMEI=**706820120206006**

The default protocol is using **TianQin** Protocol.

We could change its by SMS: protocol,password,protocol name.

Example: Protocol,123456,goomi

6.24.3 Tracking and Playback

Click the device name,there will be real-time tracking,history playback and more related operations.

Click on the "playback" to jump to the following page,you can view the history playback of the device.

Cut off engine remotely and Control the device

6.24.4 IOS &Android mobile APP

6.24.4.1 Download and install the mobile APP software

According to your phone type, download and install mobile app below the home page on web tracking platform

7 Cautions

Please comply with the instructions to extend the unit life:

- 7.1. Keep the unit dry. Any liquid, i.e. rain, moisture, may destroy or damage the inside circuitry.
- 7.2. Don't use & store the unit in dusty places.
- 7.3. Don't put the unit in overheated or overcooled places.
- 7.4. Handle carefully. Don't vibrate or shake it violently.
- 7.5. Clear the unit with a piece of dry cloth. Don't clean in chemicals, detergent.
- 7.6. Don't paint the unit, this may cause some foreign materials left in between the parts.
- 7.7. Don't disassemble or refit the unit.
- 7.8. Please read the user manual carefully before installation and operation, learn something more about the voltage range. Otherwise, it won't work properly or destroy the product.

8 Faults & the Solutions List

Faults	Solution
Fail to turn it on	Please check if built-in battery is charged, and power wires connected well.
No GSM signal	<ul style="list-style-type: none">● Please check if SIM card installed correctly.● Please check if SIM card is GSM network.● Don't turn on the PIN code● no calls can be diverted● Please check if voltage of the power is normal
No GPS	Please check if GPS antenna connected well, and recommend GPS antenna be installed near the window glass, no metal parts can cover it to make sure better GPS signal reception.
No reply to SMS command	Password wrong or the format is wrong.
No reply to calling	Authorized / admin phone number is incorrect
No alarm message	Authorized / admin phone number has not setup